



NC7SV05

TinyLogic® ULP-A Inverter (Open Drain Output)

Features

- 0.9V to 3.6V V_{CC} supply operation
- 3.6V overvoltage tolerant I/O's at V_{CC} from 0.9V to 3.6V
- Extremely High Speed t_{PD} :
 - 1.0ns typ. for 2.7V to 3.6V V_{CC}
 - 1.2ns typ. for 2.3V to 2.7V V_{CC}
 - 2.0ns typ. for 1.65V to 1.95V V_{CC}
 - 3.2ns typ. for 1.4V to 1.6V V_{CC}
 - 6.0ns typ. for 1.1V to 1.3V V_{CC}
 - 13.0ns typ. for 0.9V V_{CC}
- Power-Off high impedance inputs and outputs
- High Static Drive (I_{OH}/I_{OL}):
 - $\pm 24mA$ @ 3.00V V_{CC}
 - $\pm 18mA$ @ 2.30V V_{CC}
 - $\pm 6mA$ @ 1.65V V_{CC}
 - $\pm 4mA$ @ 1.4V V_{CC}
 - $\pm 2mA$ @ 1.1V V_{CC}
 - $\pm 0.1mA$ @ 0.9V V_{CC}
- Uses patented Quiet Series™ noise/EMI reduction circuitry
- Ultra small MicroPak™ package
- Ultra low dynamic power

General Description

The NC7SV05 is a single inverter with open drain output from Fairchild's Ultra Low Power-A series of TinyLogic®. ULP-A is ideal for applications that require extreme high speed, high drive and low power. This product is designed for a wide low voltage operating range (0.9V to 3.6V V_{CC}) and applications that require more drive and speed than the TinyLogic ULP series, but still offer best in class low power operation.

The NC7SV05 is uniquely designed for optimized power and speed, and is fabricated with an advanced CMOS technology to achieve high-speed operation while maintaining low CMOS power dissipation.

Ordering Information

Order Number	Package Number	Package Code Top Mark	Package Description	Supplied As
NC7SV05P5X	MAA05A	V05	5-Lead SC70, EIAJ SC-88a, 1.25mm Wide	3k Units on Tape and Reel
NC7SV05L6X	MAC06A	F9	6-Lead MicroPak, 1.0mm Wide	5k Units on Tape and Reel

All packages are lead free per JEDEC: J-STD-020B standard.

Battery Life vs. V_{CC} Supply Voltage

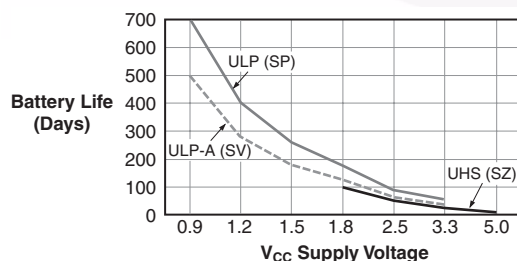

TinyLogic ULP and ULP-A with up to 50% less power consumption can extend your battery life significantly.

$$\text{Battery Life} = (V_{\text{battery}} \times I_{\text{battery}} \times 0.9) / (P_{\text{device}}) / 24\text{hrs/day}$$

$$\text{Where, } P_{\text{device}} = (I_{CC} \times V_{CC}) + (C_{PD} + C_L) \times V_{CC}^2 \times f$$

Assumes ideal 3.6V Lithium Ion battery with current rating of 900mAH and derated 90% and device frequency at 10MHz, with $C_L = 15pF$ load.

Connection Diagrams

Pin Assignment for SC70

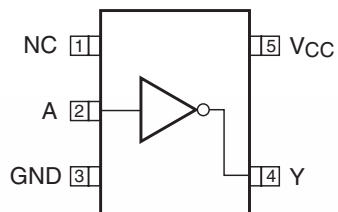

(Top View)

Pad Assignments for MicroPak

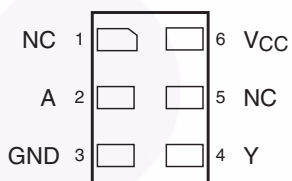

(Top Through View)

Pin Description

Pin Names	Description
A	Input
Y	Output
NC	No Connect

Logic Symbol



Function Table

$$Y = \bar{A}$$

Input	Output
A	Y
L	*H
H	L

H = HIGH Logic Level

L = LOW Logic Level

*H = HIGH Impedance Output State (Open Drain)

Absolute Maximum Ratings

Stresses exceeding the absolute maximum ratings may damage the device. The device may not function or be operable above the recommended operating conditions and stressing the parts to these levels is not recommended. In addition, extended exposure to stresses above the recommended operating conditions may affect device reliability. The absolute maximum ratings are stress ratings only.

Symbol	Parameter	Rating
V_{CC}	Supply Voltage	-0.5V to +4.6V
V_{IN}	DC Input Voltage	-0.5V to +4.6V
V_{OUT}	DC Output Voltage HIGH or LOW State ⁽¹⁾ $V_{CC} = 0V$	-0.5V to $V_{CC} + 0.5V$ -0.5V to +4.6V
I_{IK}	DC Input Diode Current @ $V_{IN} < 0V$	-50mA
I_{OK}	DC Output Diode Current $V_{OUT} < 0V$ $V_{OUT} > V_{CC}$	-50mA +50mA
I_{OH}/I_{OL}	DC Output Source/Sink Current	±50mA
I_{CC} or Ground	DC V_{CC} or Ground Current per Supply Pin	±50mA
T_{STG}	Storage Temperature Range	-65°C to +150°C
T_J	Junction Temperature Under Bias	150°C
T_L	Junction Lead Temperature (Soldering, 10 seconds)	260°C
P_D	Power Dissipation @ +85°C SC70-5 Micropak-6	150mW 130mW

Recommended Operating Conditions⁽²⁾

The Recommended Operating Conditions table defines the conditions for actual device operation. Recommended operating conditions are specified to ensure optimal performance to the datasheet specifications. Fairchild does not recommend exceeding them or designing to absolute maximum ratings.

Symbol	Parameter	Rating
V_{CC}	Supply Voltage	0.9V to 3.6V
V_{IN}	Input Voltage	0V to 3.6V
V_{OUT}	Output Voltage HIGH or LOW State $V_{CC} = 0V$	0V to V_{CC} 0V to 3.6V
I_{OH}/I_{OL}	Output Current in I_{OH}/I_{OL} $V_{CC} = 3.0V$ to 3.6V $V_{CC} = 2.3V$ to 2.7V $V_{CC} = 1.65V$ to 1.95V $V_{CC} = 1.4V$ to 1.6V $V_{CC} = 1.1V$ to 1.3V $V_{CC} = 0.9V$	±24mA ±18mA ±6mA ±4mA ±2mA ±0.1mA
T_A	Free Air Operating Temperature	-40°C to +85°C
$\Delta t/\Delta V$	Minimum Input Edge Rate @ $V_{IN} = 0.8V$ to 2.0V, $V_{CC} = 3.0V$	10ns/V
θ_{JA}	Thermal Resistance SC70-5 Micropak-6	425°C/W 500°C/W

Notes:

- I_O Absolute Maximum Rating must be observed.
- Unused inputs must be held HIGH or LOW. They may not float.

DC Electrical Characteristics

Symbol	Parameter	V _{CC} (V)	Conditions	T _A = +25°C		T _A = -40°C to +85°C		Units
				Min.	Max.	Min.	Max.	
V _{IH}	HIGH Level Input Voltage	0.90		0.65 x V _{CC}		0.65 x V _{CC}		V
		1.10 ≤ V _{CC} ≤ 1.30		0.65 x V _{CC}		0.65 x V _{CC}		
		1.40 ≤ V _{CC} ≤ 1.60		0.65 x V _{CC}		0.65 x V _{CC}		
		1.65 ≤ V _{CC} ≤ 1.95		0.65 x V _{CC}		0.65 x V _{CC}		
		2.30 ≤ V _{CC} < 2.70		1.6		1.6		
		2.70 ≤ V _{CC} ≤ 3.60		2.0		2.0		
V _{IL}	LOW Level Input Voltage	0.90			0.35 x V _{CC}		0.35 x V _{CC}	V
		1.10 ≤ V _{CC} ≤ 1.30			0.35 x V _{CC}		0.35 x V _{CC}	
		1.40 ≤ V _{CC} ≤ 1.60			0.35 x V _{CC}		0.35 x V _{CC}	
		1.65 ≤ V _{CC} ≤ 1.95			0.35 x V _{CC}		0.35 x V _{CC}	
		2.30 ≤ V _{CC} < 2.70			0.7		0.7	
		2.70 ≤ V _{CC} ≤ 3.60			0.8		0.8	
V _{OL}	LOW Level Output Voltage	0.90	I _{OL} = 100μA		0.1		0.1	V
		1.10 ≤ V _{CC} ≤ 1.30			0.1		0.1	
		1.40 ≤ V _{CC} ≤ 1.60			0.2		0.2	
		1.65 ≤ V _{CC} ≤ 1.95			0.2		0.2	
		2.30 ≤ V _{CC} < 2.70			0.2		0.2	
		2.70 ≤ V _{CC} ≤ 3.60			0.2		0.2	
		1.10 ≤ V _{CC} ≤ 1.30	I _{OL} = 2mA		0.25 x V _{CC}		0.25 x V _{CC}	
		1.40 ≤ V _{CC} ≤ 1.60	I _{OL} = 4mA		0.25 x V _{CC}		0.25 x V _{CC}	
		1.65 ≤ V _{CC} ≤ 1.95	I _{OL} = 6mA		0.3		0.3	
		2.30 ≤ V _{CC} < 2.70	I _{OL} = 12mA		0.4		0.4	
		2.70 ≤ V _{CC} ≤ 3.60			0.4		0.4	
		2.30 ≤ V _{CC} < 2.70	I _{OL} = 18mA		0.6		0.6	
		2.70 ≤ V _{CC} ≤ 3.60			0.4		0.4	
		2.70 ≤ V _{CC} ≤ 3.60	I _{OL} = 24mA		0.55		0.55	
I _{IN}	Input Leakage Current	0.90 to 3.60	0 ≤ V _I ≤ 3.6V		±0.1		±0.5	μA
I _{OFF}	Power Off Leakage Current	0	0 ≤ (V _I , V _O) ≤ 3.6V		0.5		0.5	μA
I _{CC}	Quiescent Supply Current	0.90 to 3.60	V _I = V _{CC} or GND		0.9		0.9	μA
			V _{CC} ≤ V _I ≤ 3.6V				±0.9	

AC Electrical Characteristics

Symbol	Parameter	V _{CC} (V)	Conditions	T _A = +25°C			T _A = -40°C to +85°C		Units	Figure Number
				Min.	Typ.	Max.	Min.	Max.		
t _{PZL} , t _{PLZ}	Propagation Delay	0.90	C _L = 15pF, R _U = R _D = 1kΩ		13				ns	Figure 1 Figure 2
		1.10 ≤ V _{CC} ≤ 1.30	C _L = 30pF, R _U = R _D = 1kΩ	3.0	6.0	15.0	1.0	18.6		
		1.40 ≤ V _{CC} ≤ 1.60		1.0	3.2	8.7	1.0	9.7		
		1.65 ≤ V _{CC} ≤ 1.95	C _L = 30pF, R _U = R _D = 1kΩ	1.0	2.0	6.0	1.0	6.8		
		2.30 ≤ V _{CC} < 2.70		0.8	1.2	3.6	0.7	4.7		
		2.70 ≤ V _{CC} ≤ 3.60		0.7	1.0	3.3	0.6	4.0		
C _{IN}	Input Capacitance	0			2.0				pF	
C _{PD}	Power Dissipation Capacitance	0.90 to 3.60	V _I = 0V or V _{CC} , f = 10MHz		10				pF	

AC Loading and Waveforms

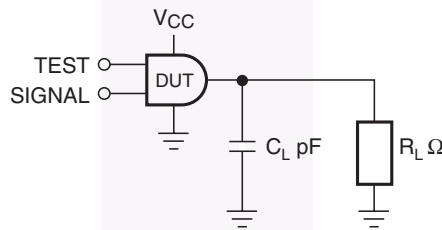

Figure 1. AC Test Circuit

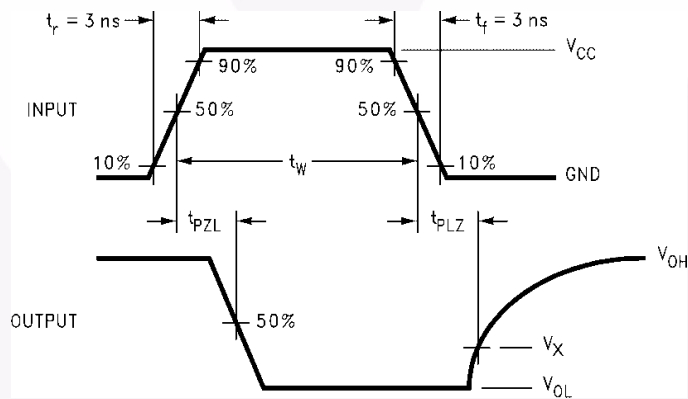

Figure 2. Waveform for Inverting and Non-Inverting Functions

Symbol	V _{CC}					
	3.3V ± 0.3V	2.5V ± 0.2V	1.8V ± 0.15V	1.5V ± 0.1V	1.2V ± 0.1V	0.9V
V _{mi}	1.5V	V _{CC} / 2	V _{CC} / 2	V _{CC} / 2	V _{CC} / 2	V _{CC} / 2
V _x	V _{OL} + 0.3V	V _{OL} + 0.15V	V _{OL} + 0.15V	V _{OL} + 0.1V	V _{OL} + 0.1V	V _{OL} + 0.1V

Tape and Reel Specification (Continued)

Tape Format for MicroPak

Package Designator	Tape Section	Number Cavities	Cavity Status	Cover Tape Status
L6X	Leader (Start End)	125 (typ.)	Empty	Sealed
	Carrier	5000	Filled	Sealed
	Trailer (Hub End)	75 (typ.)	Empty	Sealed

Tape Dimension millimeters

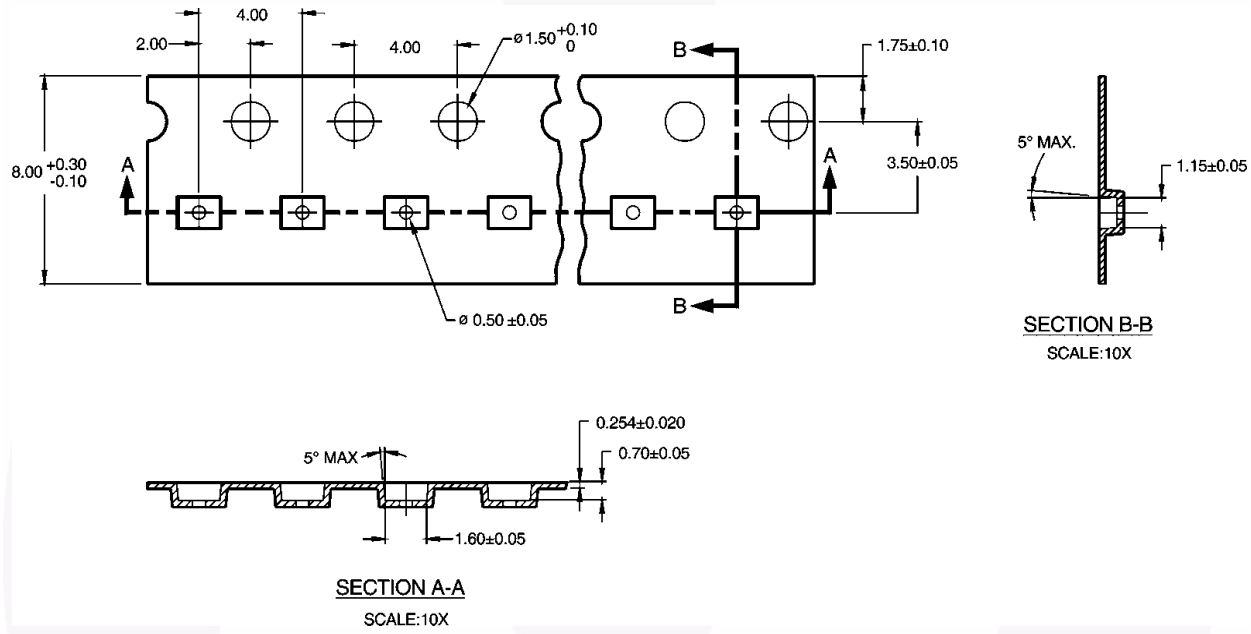

Tape and Reel Specification (Continued)

Reel Dimension for MicroPak inches (millimeters)

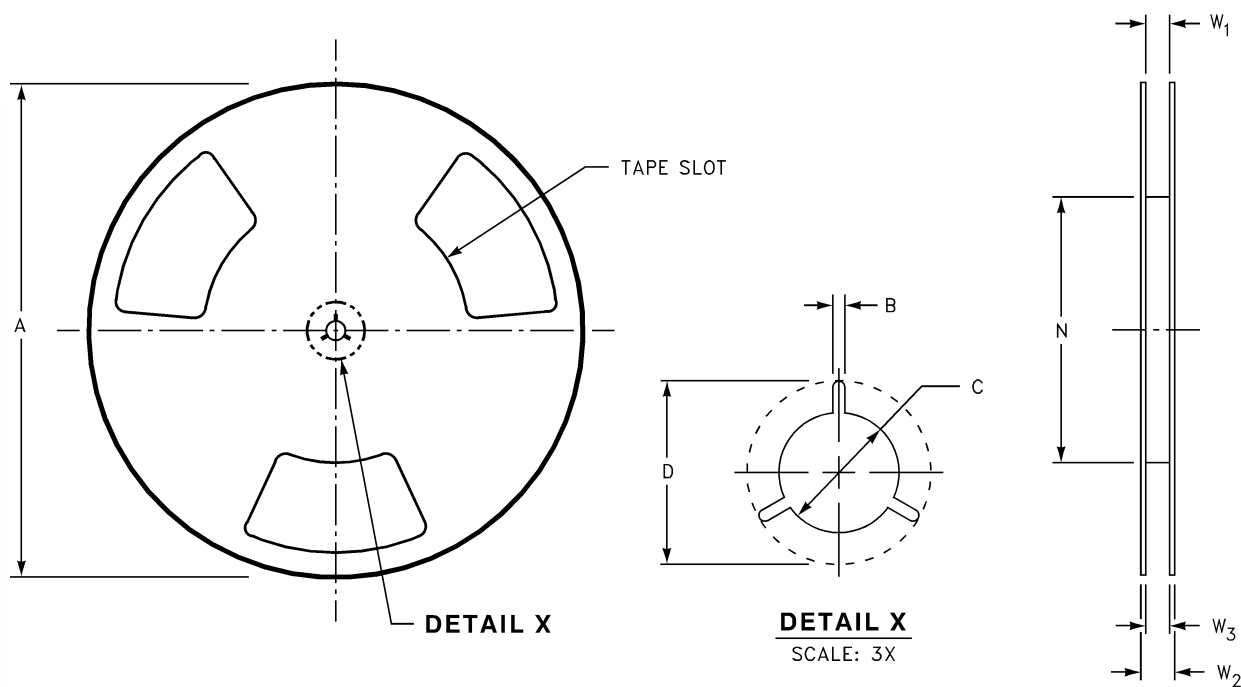

Tape Size	A	B	C	D	N	W ₁	W ₂	W ₃
8mm	7.0 (177.8)	0.059 (1.50)	0.512 (13.00)	0.795 (20.20)	2.165 (55.00)	0.331 +0.059/-0.000 (8.40 +1.50/-0.00)	0.567 (14.40)	W1 +0.078/-0.039 (W1 +2.00/-1.00)

Physical Dimensions

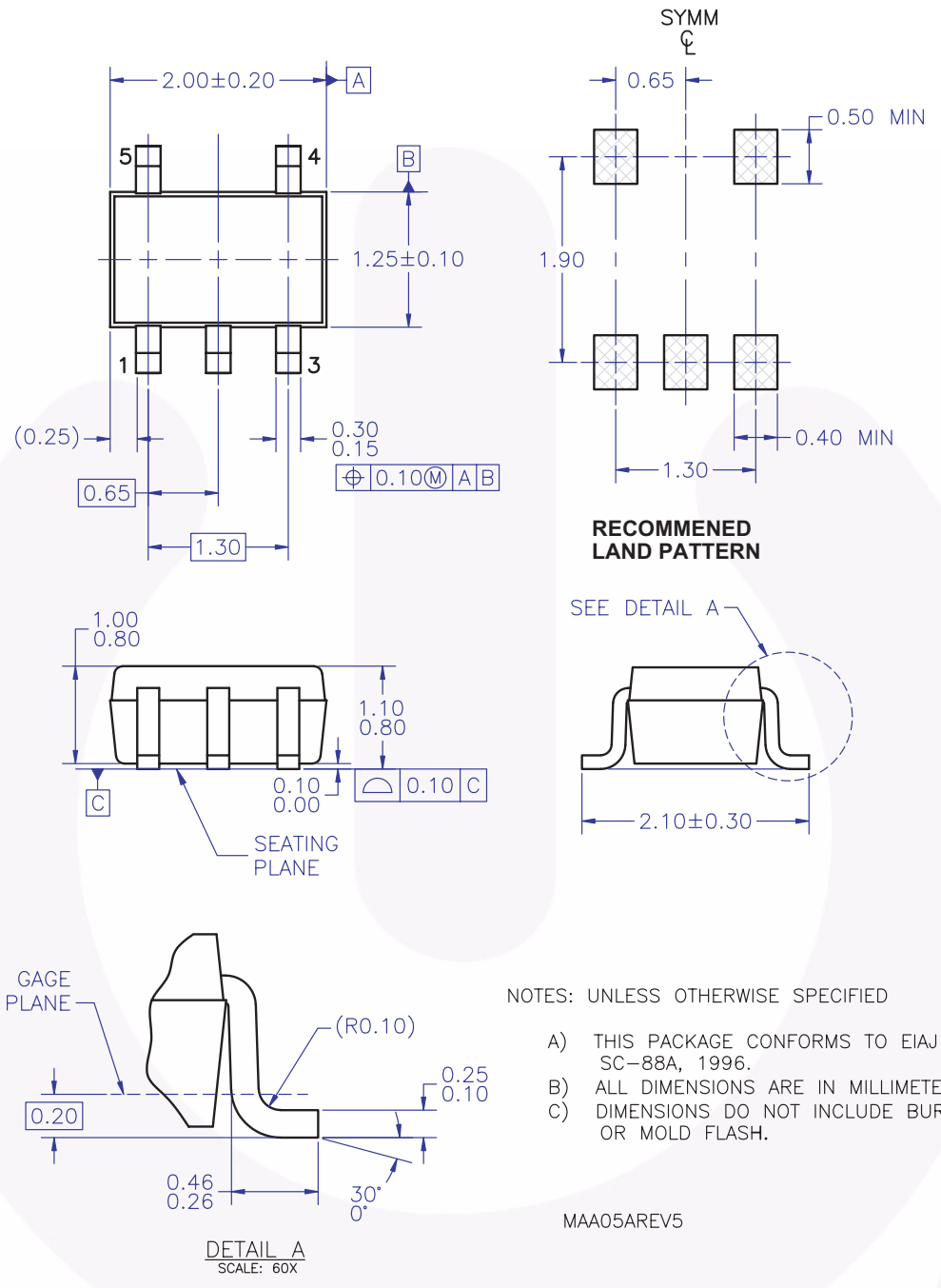
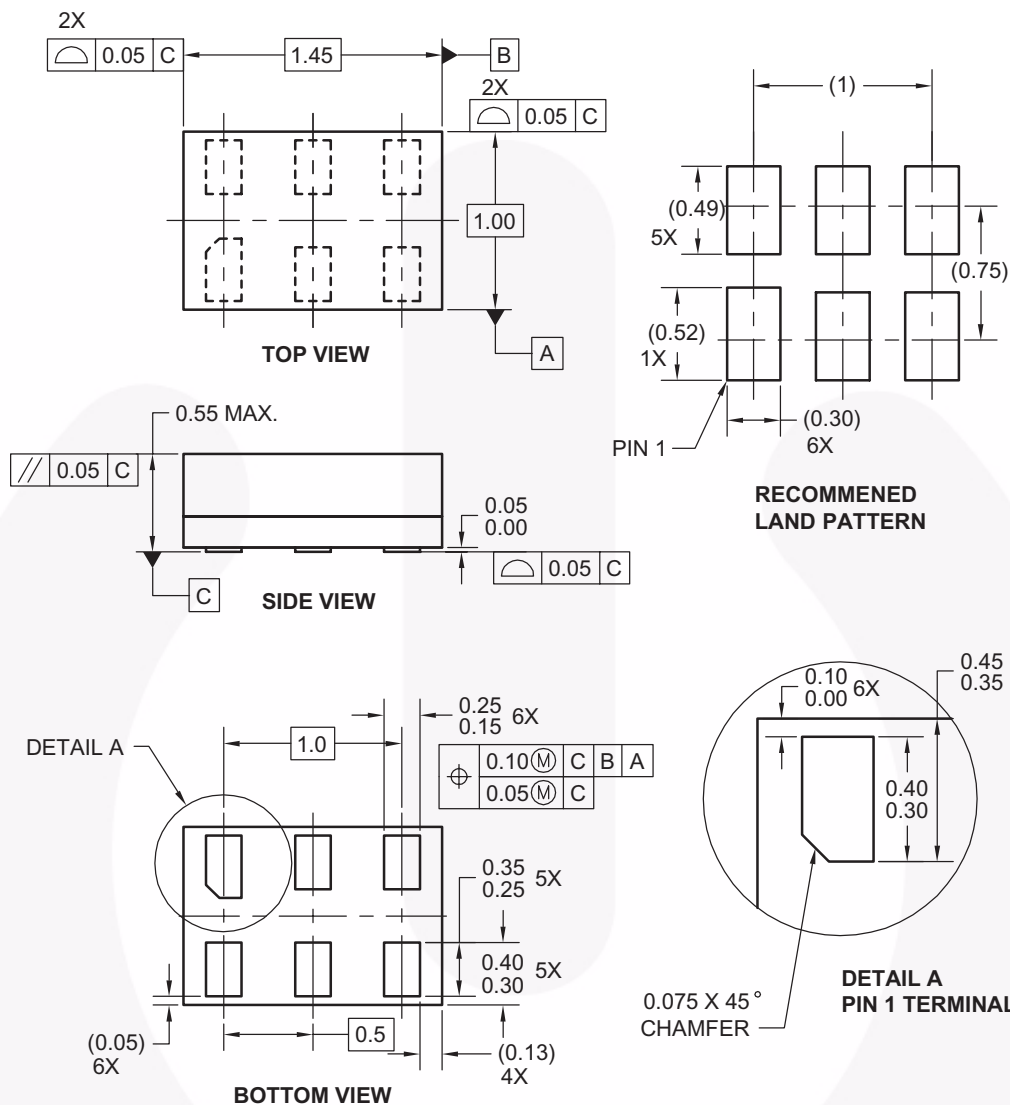

Figure 3. 5-Lead SC70, EIAJ SC-88a, 1.25mm Wide

Package drawings are provided as a service to customers considering Fairchild components. Drawings may change in any manner without notice. Please note the revision and/or date on the drawing and contact a Fairchild Semiconductor representative to verify or obtain the most recent revision. Package specifications do not expand the terms of Fairchild's worldwide terms and conditions, specifically the warranty therein, which covers Fairchild products.

Always visit Fairchild Semiconductor's online packaging area for the most recent package drawings:
<http://www.fairchildsemi.com/packaging/>

Physical Dimensions (Continued)



Notes:

1. CONFORMS TO JEDEC STANDARD M0-252 VARIATION UAAD
2. DIMENSIONS ARE IN MILLIMETERS
3. DRAWING CONFORMS TO ASME Y14.5M-1994

MAC06AREVC

Figure 4. 6-Lead MicroPak, 1.0mm Wide

Package drawings are provided as a service to customers considering Fairchild components. Drawings may change in any manner without notice. Please note the revision and/or date on the drawing and contact a Fairchild Semiconductor representative to verify or obtain the most recent revision. Package specifications do not expand the terms of Fairchild's worldwide terms and conditions, specifically the warranty therein, which covers Fairchild products.





Always visit Fairchild Semiconductor's online packaging area for the most recent package drawings:

<http://www.fairchildsemi.com/packaging/>



TRADEMARKS

The following includes registered and unregistered trademarks and service marks, owned by Fairchild Semiconductor and/or its global subsidiaries, and is not intended to be an exhaustive list of all such trademarks.

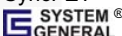
ACEx®	FPS™	PDP SPM™	The Power Franchise®
Build it Now™	F-PFS™	Power-SPM™	the power franchise
CorePLUS™	FRFET®	PowerTrench®	TinyBoost™
CorePOWER™	Global Power Resource™	Programmable Active Droop™	TinyBuck™
CROSSVOLT™	Green FPS™	QFET®	TinyLogic™
CTL™	Green FPS™ e-Series™	QS™	TINYOPTO™
Current Transfer Logic™	GTO™	Quiet Series™	TinyPower™
EcoSPARK®	IntelliMAX™	RapidConfigure™	TinyPWM™
EfficientMax™	ISOPLANAR™	Saving our world, 1mW at a time™	TinyWire™
EZSWITCH™ *	MegaBuck™	SmartMax™	μSerDes™
 ™	MICROCOUPLER™	SMART START™	
 ™	MicroFET™	SPM®	UHC®
Fairchild®	MicroPak™	STEALTH™	Ultra FRFET™
Fairchild Semiconductor®	MillerDrive™	SuperFET™	UniFET™
FACT Quiet Series™	MotionMax™	SuperSOT™-3	VCX™
FACT®	Motion-SPM™	SuperSOT™-6	VisualMax™
FAST®	OPTOLOGIC®	SuperSOT™-8	
FastvCore™	OPTOPLANAR®	SupreMOS™	
FlashWriter®		SyncFET™	
			

* EZSWITCH™ and FlashWriter® are trademarks of System General Corporation, used under license by Fairchild Semiconductor.

DISCLAIMER

FAIRCHILD SEMICONDUCTOR RESERVES THE RIGHT TO MAKE CHANGES WITHOUT FURTHER NOTICE TO ANY PRODUCTS HEREIN TO IMPROVE RELIABILITY, FUNCTION, OR DESIGN. FAIRCHILD DOES NOT ASSUME ANY LIABILITY ARISING OUT OF THE APPLICATION OR USE OF ANY PRODUCT OR CIRCUIT DESCRIBED HEREIN; NEITHER DOES IT CONVEY ANY LICENSE UNDER ITS PATENT RIGHTS, NOR THE RIGHTS OF OTHERS. THESE SPECIFICATIONS DO NOT EXPAND THE TERMS OF FAIRCHILD'S WORLDWIDE TERMS AND CONDITIONS, SPECIFICALLY THE WARRANTY THEREIN, WHICH COVERS THESE PRODUCTS.

LIFE SUPPORT POLICY

FAIRCHILD'S PRODUCTS ARE NOT AUTHORIZED FOR USE AS CRITICAL COMPONENTS IN LIFE SUPPORT DEVICES OR SYSTEMS WITHOUT THE EXPRESS WRITTEN APPROVAL OF FAIRCHILD SEMICONDUCTOR CORPORATION.

As used herein:

1. Life support devices or systems are devices or systems which, (a) are intended for surgical implant into the body or (b) support or sustain life, and (c) whose failure to perform when properly used in accordance with instructions for use provided in the labeling, can be reasonably expected to result in a significant injury of the user.
2. A critical component in any component of a life support, device, or system whose failure to perform can be reasonably expected to cause the failure of the life support device or system, or to affect its safety or effectiveness.

PRODUCT STATUS DEFINITIONS

Definition of Terms

Datasheet Identification	Product Status	Definition
Advance Information	Formative / In Design	This datasheet contains the design specifications for product development. Specifications may change in any manner without notice.
Preliminary	First Production	This datasheet contains preliminary data; supplementary data will be published at a later date. Fairchild Semiconductor reserves the right to make changes at any time without notice to improve design.
No Identification Needed	Full Production	This datasheet contains final specifications. Fairchild Semiconductor reserves the right to make changes at any time without notice to improve the design.
Obsolete	Not In Production	This datasheet contains specifications on a product that is discontinued by Fairchild Semiconductor. The datasheet is for reference information only.

Rev. I34